

# Mitutoyo

Mitutoyo Quality

## CNC Coordinate Measuring Machine CRYSTA-Apex V Series

COORDINATE  
MEASURING MACHINES



To the next level

# *CRYSTA-Apex* *V* SERIES

500/700/900/1200/1600/2000 Series

Introducing a new generation CNC coordinate measuring machine focused on accuracy, speed, and versatility.

We are proud to unveil our CRYSTA-Apex V Series that delivers faster measurement of small- to large sized parts without compromising the measuring machine's inherent accuracy, and helps make the smart factory a reality.

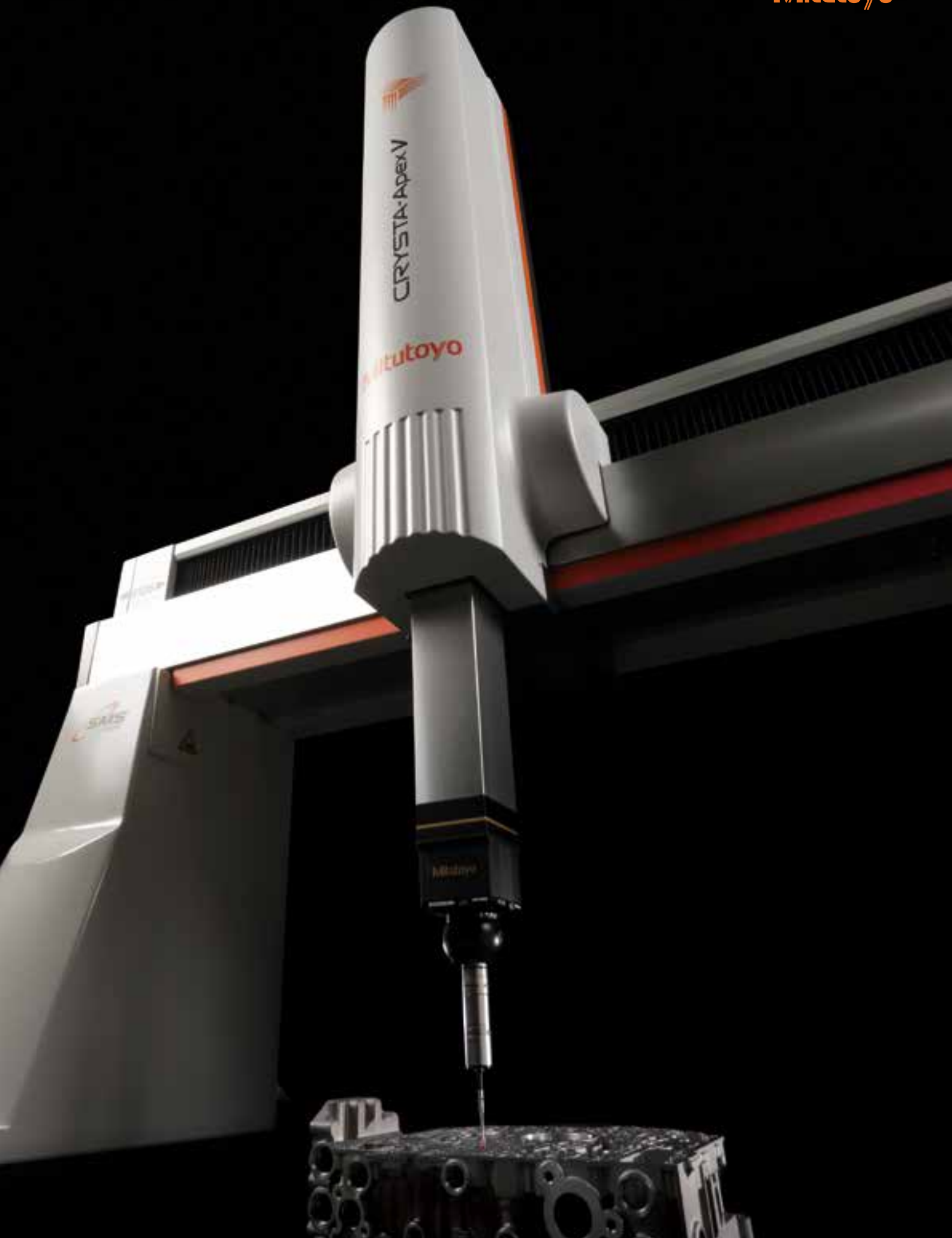

A brand new CMM design that provides cutting-edge capability in an extensive series of models that covers practically any measurement application in the small- to large sized part range.

The aesthetic design sports bold colours that befits a precision measuring instrument of the IoT age. Offering a choice of models for measuring from small to large sized workpieces, the CRYSTA-Apex V Series delivers advances in accuracy, speed and versatility in this class of CMM.



CRYSTA-Apex V544

**Measuring range**

X: 500 mm  
Y: 400 mm  
Z: 400 mm



CRYSTA-Apex V776

**Measuring range**

X: 700 mm  
Y: 700 mm  
Z: 600 mm



CRYSTA-Apex V162012



CRYSTA-Apex V203016



CRYSTA-Apex V9106

**Measuring range**

X: 900 mm  
Y: 1000 mm  
Z: 600 mm



CRYSTA-Apex V122010

**Measuring range**

X: 1200 mm  
Y: 2000 mm  
Z: 1000 mm

Note: All models incorporate a main unit Startup system (relocation detection system), which disables operation when an unexpected vibration is applied or the machine is relocated. Be sure to contact your nearest Mitutoyo Sales Office prior to relocating this machine after initial installation.

# *HIGH PRECISION*



---

## Absolute quality

Provides a performance specification unmatched by any previous CMM of this class through features that include an advanced real-time thermal compensation system which makes measurement accuracy practically independent of temperature changes in the environment. This is in stark contrast to earlier generation CMMs where accuracy could not be guaranteed unless the machine was installed in the controlled environment of a measuring room held as closely as possible at the standard temperature of 20 °C.

## Real-time temperature compensation

Mitutoyo's thermal compensation system technology enables the CRYSTA-Apex V Series to maintain specified accuracy over the wide temperature range of 16-26 °C. The system operates by continuously tracking the temperature of the workpiece and every scale on the CMM and using this data to calculate and apply corrections to the measurement output. Thus the CMM appears to be performing as if it is always operating at a constant temperature of precisely 20 °C.

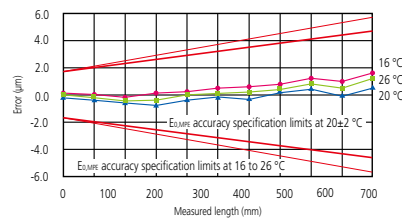

Graph showing the effectiveness of temperature compensation

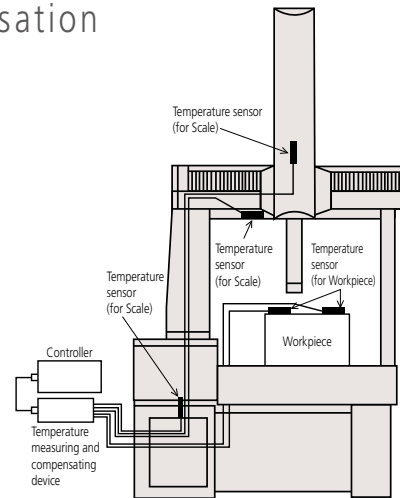

## High accuracy in the 1.7 µm class

The CRYSTA-Apex V Series guarantees a maximum permissible length measurement error ( $E_{0,MPE}$ ) of  $1.7 + 3L/1000 \mu\text{m}$ , a specification that compares very favourably with a standard CMM offering an  $E_{0,MPE}$  of  $2.5 + 4L/1000 \mu\text{m}$ , which would generally be considered high accuracy. To illustrate the practical advantage of the higher specification of the CRYSTA-Apex V Series, consider the case where the tolerance on a dimension is  $\pm 0.02 \text{ mm}$ : the measurement uncertainty of the standard machine exceeds one-fifth of this tolerance\* for any length over 375 mm. In contrast, the V Series uncertainty remains within one-fifth of the tolerance for measured lengths up to 766 mm. Hence the V Series actually offers guaranteed accuracy over more than double the measuring range of the less accurate standard machine.

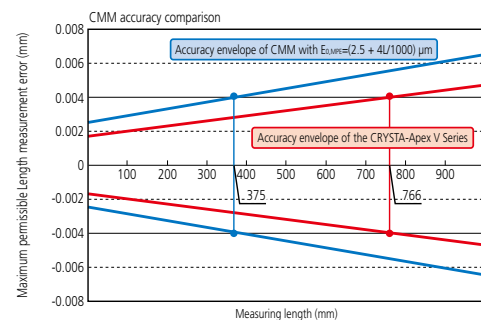

\* Assuming an acceptable working ratio between component tolerance and accuracy of measurement is 5:1 minimum.

## Repeatability

Excellent measurement repeatability is essential for high accuracy and this is especially true when using scanning probes to measure complex 3D surfaces, an application where dynamic errors can occur if precautions are not taken. In this scenario the data from the scanning probe is stabilised by holding the probe stationary for a short time whenever the stylus tip contacts the workpiece, thereby ensuring that inertial causes of dynamic error are eliminated, making it possible to deliver the best possible level of repeatability obtainable from the CRYSTA-Apex V Series machines.



# HIGH SPEED

## Dramatically reduces measurement time with high-speed measurements

The V Series enables users to freely set measurement paths along three-dimensional surfaces, enabling complex workpieces to be measured most efficiently. High-speed measurement is unaffected by processing accuracy through real-time correction of path errors caused by differences between workpiece and design values. The V Series, with its high drive speed and acceleration combined with a maximum measuring speed of 8 mm/s, dramatically reduces total measuring time.





## Speed and acceleration to reduce measurement time

The CRYSTA-Apex V Series offers a maximum drive speed of 519 mm/s and a maximum acceleration of 2,309 mm/s<sup>2</sup>. Compared with conventional CNC CMMs (typically around 430 mm/s and 1,650 mm/s<sup>2</sup>), this amounts to about 100 mm more traverse distance one second after starting movement. This faster movement capability, combined with a maximum measuring speed (the speed with which the stylus traces over the workpiece) of 8 mm/s, much faster than conventional CNC CMMs (typically around 5 mm/s), cuts total measuring time significantly. The more the number of measurement locations, the greater this margin grows, which in turn results in significant cost savings.



## High-speed optimum path scanning

The V Series is equipped with a measurement feature that allows users to specify scanning measurement paths (design values). This feature allows for high speed, high-accuracy scanning by correcting dynamic errors that would otherwise be produced by acceleration and deceleration stresses. Measurement paths can be freely specified for three-dimensional forms as well, which enables intricate workpieces to be measured by tracking precisely along their curved surfaces and contours.



## Active scanning feature

Enables high-speed measurement by accommodating discrepancies between design values and the actual workpiece. The 3D optimal path scanning advantages are retained whilst allowing for manufacturing or alignment deviations. The complexity of some workpieces. (e.g. turbine blades, fan blades and impellers) makes measurement difficult as their manufacturing variation fluctuates more than most machined parts. The V Series can tolerate these differences and still perform accurate measurement.

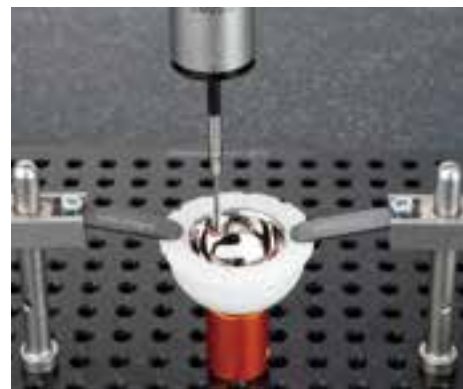

# DIVERSITY

Efficient, high-accuracy measurement of practically any part shape

The CRYSTA-Apex V Series is suitable for a wide range of applications using touch-trigger, scanning and non-contact probes in fully automatic part-program measurement cycles.

SurfaceMeasure  
Mitutoyo  
FLYING SPOT LASER PROBE  
201F5

## Probes for Coordinate Measuring Machines

### Compact high-accuracy scanning probe SP25M

The SP25M is a compact, high-accuracy scanning probe with a 25-mm outside diameter. It is a multi-function CNC CMM probe that can collect data not only from scanning measurements, where the probe moves while in contact with the workpiece to collect a point-cloud of coordinate values, but from high-accuracy single-point measurements as well.



### Non-contact laser probe SurfaceMeasure

SurfaceMeasure is a non-contact probe that collects coordinate values of the surface of a workpiece by using laser light. It can quickly obtain a point-cloud of 3D surface data.



Measuring color sample boards

Measuring glossy workpieces



### Automatic probe changer ACR3

This fixture is necessary when using probes that do not support automatic stylus exchange for fully automated measurements that require changes in stylus diameter and/or length. It is also needed for part programs that require switching between contact and non-contact probes. Newly designed with a simpler structure and increased durability due to a new mechanism that uses the drive of the CMM for automatic exchange.



Unlock

Lock

## Efficient, high-accuracy measurement in a variety of applications

The CRYSTA-Apex V Series is suitable for a wide range of applications using touch-trigger, scanning and non-contact probes in fully automatic part-program measurement cycles.

---

### Electric-cell separator moulds Electric vehicle

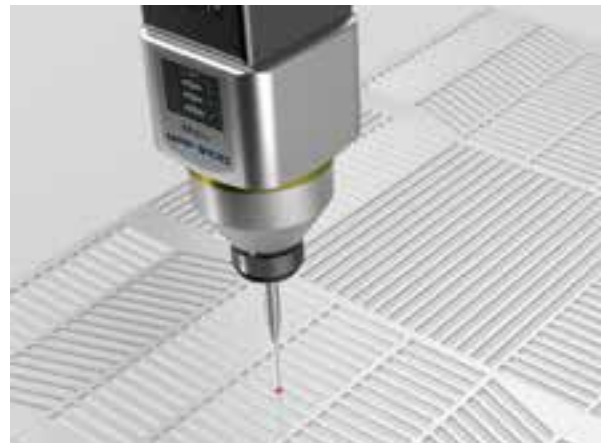

Surface and cross-section measurements on precision moulds for the separators used in electric cells can be made using a low measuring force, high-accuracy scanning probe. Three-dimensional error and cross-sectional form analyses may be performed using the measurement data obtained.

---

### Pump impellers Automobile



Complex shapes such as pump impellers can be measured using a robust non-contact laser probe that produces huge amounts of data in the form of a point cloud to provide highly detailed measurement data for excellent characterisation of the part.

## Electric motor cores

Electric vehicle

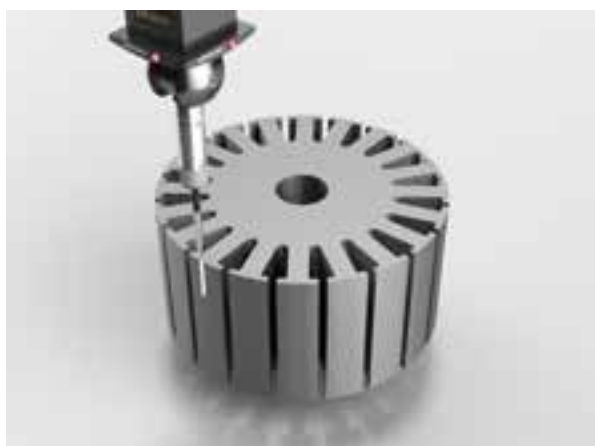

Surface and cross-section measurements on precision moulds for the separators used in electric cells can be made using a low measuring force, high-accuracy scanning probe. Three-dimensional error and cross-sectional form analyses may be performed using the measurement data obtained.

## Turbine and fan blades

Aircraft



The cross-section of aircraft engine aerofoil components can be measured using a compact, high-accuracy scanning probe. Even workpieces susceptible to large errors, such as castings, can be measured quickly and reliably.

## Artificial joints

Medical care



Freeform surface measurement of artificial joints can be made using a compact, high-accuracy scanning probe. Three-dimensional error analysis can be performed using the measurement data obtained.

## Transmission cases

Power trains



Non-contact laser probes require dramatically less measurement time compared to contact (scanning) probes. Scanning from three directions enables simultaneous measurement of the top and side faces, which means less repositioning and efficient measurement of even the most intricate parts.

# SOFTWARE

Application software that offers functionality and ease of use

Mitutoyo offers an extensive choice of application software for automatically generating part programs to perform measurement and evaluation of simple or complex components, including gears and aerofoils. Practically any measurement challenges that our customers may encounter can be tackled by V Series machines.

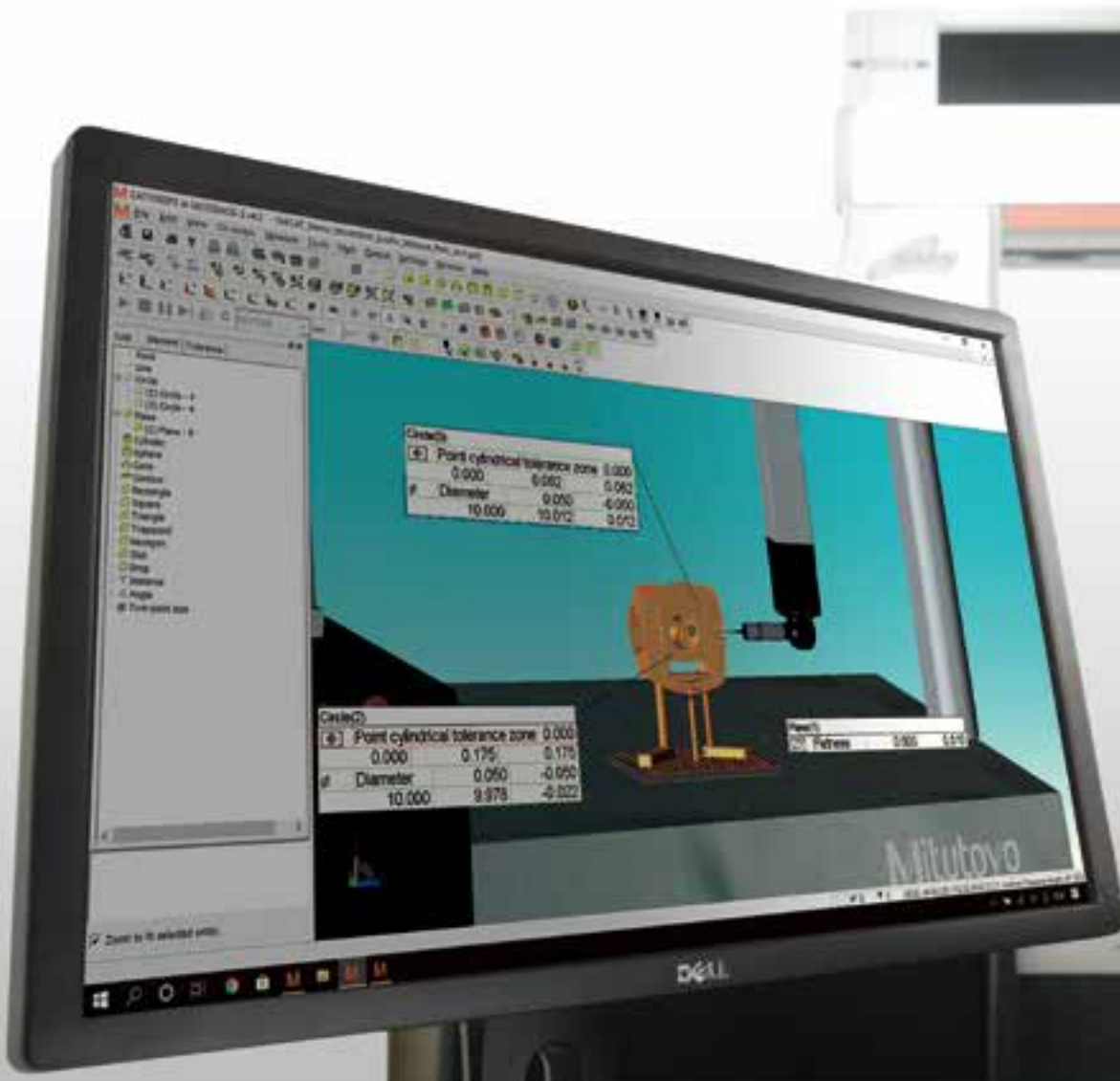



## MCOSMOS

### Data processing

MCOSMOS is Mitutoyo's suite of PC-based CMM software applications that consists of optional modules to support fully automated measurement of all kinds.

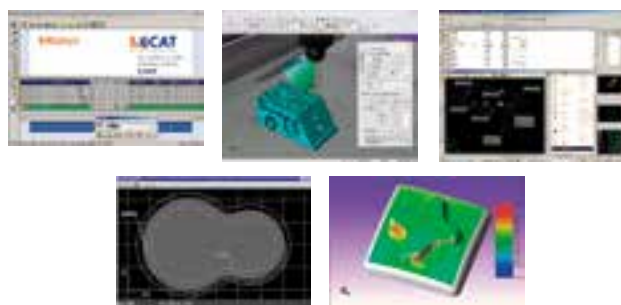

## MiCAT Planner

### Automatic part-program generating

This software package dramatically reduces part-programming creation time by automatically generating the part program. Tolerance information from a 3D CAD model is read to determine which features of the part should be measured to verify conformance to specification. Compared to conventional methods (teaching), this method creates more-efficient measurement programs as well as saving time.



## MSURF

### Scanning and evaluation by laser probe

The MSURF software package comprises MSURF-S for scanning measurement of a part and MSURF-I for comparing the resulting measurement data against the master model data.

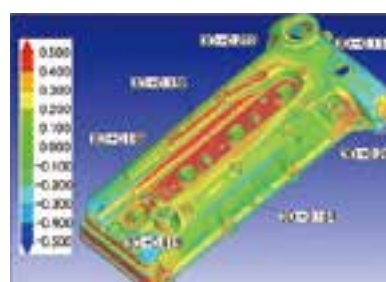

# SMART FACTORY

From status management to preventive maintenance.  
Kickstart your smart factory through visualization.

Mitutoyo has developed new features that use a network to centrally manage manufacturing process information. The MeasurLink software package helps prevent defective parts by collecting and analyzing measurement data in real time. The Status Monitor (Smart Measuring System, or SMS), which indicates the operational status of the measuring machine; and the Condition Monitor, which indicates the physical condition of the machine itself, help maintain measurement accuracy, increase productivity, and improve maintenance management.



## Status Monitor

Remote machine monitoring







### Condition Monitor

Conduct preventive maintenance through CMM status monitoring

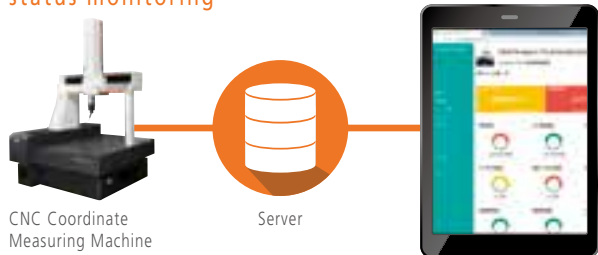

**Output information**

- Slideway distance travelled
- Temperature log
- Number of probe inputs
- Other selectable information

→ Preventive maintenance through status monitoring

### MeasurLink

Reduces defective products by visualizing quality

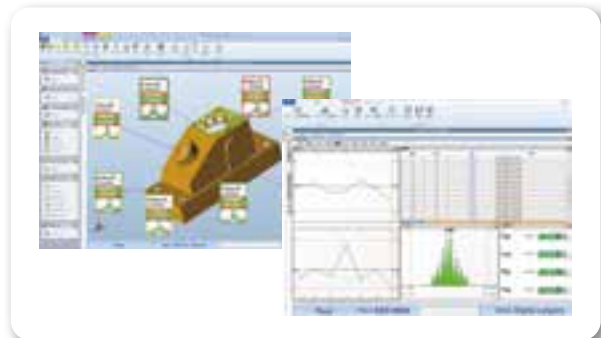

# USABILITY

---

## Effectively reduces operation and measurement time through enhanced convenience and usability

The V Series is equipped with the Quick Launcher to improve operability and a joystick box that lets users remotely control their measuring machine as though it were right in front of them. These enhancements in usability enable the workflow to be streamlined by reducing measurement time.

### Part program execution

---

The Quick Launcher enables simple and intuitive operation for easy part program execution. The touch-panel monitor further improves operability, making operations practically effortless for anyone. Part programs can also be executed via barcodes and QR codes.



### Joystick box

---

The joystick box allows users to easily operate their CRYSTA-Apex V Series CMM from a remote location. It comes with control buttons marked with user-friendly icons and an override knob for changing speed.



### MiCAT Planner

---

This software package dramatically reduces part-programming creation time by automatically generating the part program. Tolerance information from a 3D CAD model is read to determine which features of the part should be measured to verify conformance to specification. Compared to conventional methods (teaching), this method creates more-efficient measurement programs as well as saving time.



# OPTIONS

## To support fully automated measurement and efficient setups

Options that support fully automated measurement to capitalize on the advantages of CNC CMMs, and that promote efficient setups to reduce cycle time.

### Automation example

The V Series' ability to deliver high-accuracy measurements across a wide temperature range eliminates the need for a dedicated measuring room. This allows for the automation of in-line and line-side measurements within the manufacturing process to significantly reduce measurement time and streamline the workflow.



### Clamping system Eco-Fix Kit

Mitutoyo clamping tools comprise of a clamping system where elements can be put together like toy construction blocks to easily fix workpieces in place on the measuring table.



### Rotary table

This is a precision orientation device for CNC CMMs to aid efficient and high-accuracy measurement of rotational-form components such as gears, impellers, screw rotors and cams. Can be synchronized with a scanning probe to enable a wide range of contour measurements to broaden the application range of a CMM.

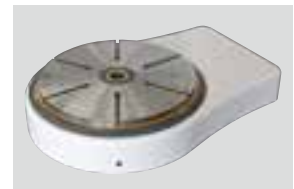

Coordinate Measuring Machines

Vision Measuring Systems

Form Measurement

Optical Measuring

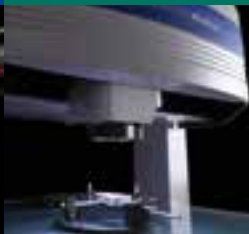

Sensor Systems

Test Equipment

Digital Scale and DRO Systems

Small Tool Instruments and Data Management



**Whatever your challenges are, Mitutoyo supports you from start to finish.**

Mitutoyo is not only a manufacturer of top quality measuring products but one that also offers qualified support for the lifetime of the equipment, backed up by comprehensive services that ensure your staff can make the very best use of the investment.

Apart from the basics of calibration and repair, Mitutoyo offers product and metrology training, as well as IT support for the sophisticated software used in modern measuring technology. We can also design, build, test and deliver bespoke measuring solutions and even, if deemed cost-effective, take your critical measurement challenges in-house on a sub-contract basis.

Note: Product illustrations are without obligation. Product descriptions, in particular any and all technical specifications, are only binding when explicitly agreed upon.

MITUTOYO and MICAT are either registered trademarks or trademarks of Mitutoyo Corp. in Japan and/or other countries/regions. Other product, company and brand names mentioned herein are for identification purposes only and may be the trademarks of their respective holders.

Our products are classified as regulated items under Japanese Foreign Exchange and Foreign Trade Law. Please consult us in advance if you wish to export our products to any other country. If the purchased product is exported, even though it is not a regulated item (Catch-All controls item), the customer service available for that product may be affected. If you have any questions, please consult your local Mitutoyo sales office



### Mitutoyo Asia Pacific Pte. Ltd.

Company Reg No. 197800892N

24 Kallang Avenue, Mitutoyo Building, Singapore 339415

Tel: (65) 6294 2211 Fax: (65) 6299 6666

E-mail: [mapsg@mitutoyo.com.sg](mailto:mapsg@mitutoyo.com.sg)

[www.mitutoyo.com.sg](http://www.mitutoyo.com.sg) | [www.mitutoyo.com.my](http://www.mitutoyo.com.my)  
[www.mitutoyo.co.th](http://www.mitutoyo.co.th) | [www.mitutoyo.co.id](http://www.mitutoyo.co.id)  
[www.mitutoyo.com.vn](http://www.mitutoyo.com.vn) | [www.mitutoyo.com.ph](http://www.mitutoyo.com.ph)



#### Mitutoyo (Malaysia) Sdn. Bhd.

Mah Sing Integrated Industrial Park,  
4, Jalan Utarid U5/14, Section U5,  
40150 Shah Alam, Selangor, Malaysia

Tel: (60) 3-7845 9318

Fax: (60) 3-7845 9346

E-mail: [mmsb@mitutoyo.com.my](mailto:mmsb@mitutoyo.com.my)

#### Penang Branch

Tel: (60) 4-641 1998 Fax: (60) 4-641 2998

#### Johor Branch

Tel: (60) 7-352 1626 Fax: (60) 7-352 1628

#### Mitutoyo (Thailand) Co., Ltd.

76/3-5, Chaengwattana Road, Kwaeng  
Anusaawaree, Khet Bangkaen,  
Bangkok 10220, Thailand

Tel: (66) 2080 3500

Fax: (66) 2521 6136

E-mail: [office@mitutoyo.co.th](mailto:office@mitutoyo.co.th)

#### Chonburi Branch

Tel: (66) 2080 3563 Fax: (66) 3834 5788

#### ACC Branch

Tel: (66) 2080 3565

#### PT. Mitutoyo Indonesia

Jalan Sriwijaya No.26  
Desa cibatu  
Kec. Cikarang Selatan  
Kab. Bekasi 17530, Indonesia

Tel: (62) 21-2962 8600

Fax: (62) 21-2962 8604

E-mail: [ptmi@mitutoyo.co.id](mailto:ptmi@mitutoyo.co.id)

#### Mitutoyo Vietnam Co., Ltd.

1st & 2nd Floor, MHDI Building,  
No. 60 Hoang Quoc Viet Road,  
Nghia Do Ward, Cau Giay District,  
Hanoi, Vietnam

Tel: (84) 24-3768 8963

Fax: (84) 24-3768 8960

E-mail: [mvc@mitutoyo.com.vn](mailto:mvc@mitutoyo.com.vn)

#### Ho Chi Minh City Branch

Tel: (84) 28-3840 3489

Fax: (84) 28-3840 3498

#### Hai Phong City Branch

Tel: (84) 22-5398 9909

#### Mitutoyo Philippines, Inc.

Unit 1B & 2B LTI,  
Administration Building 1,  
Annex 1, North Main Avenue,  
Laguna Technopark, Biñan,  
Laguna 4024, Philippines

Tel: (63) 49-544 0272

Fax: (63) 49-544 0272

E-mail: [mpi@mitutoyo.com.ph](mailto:mpi@mitutoyo.com.ph)